

DRESSING & TISSUE FORCEPS

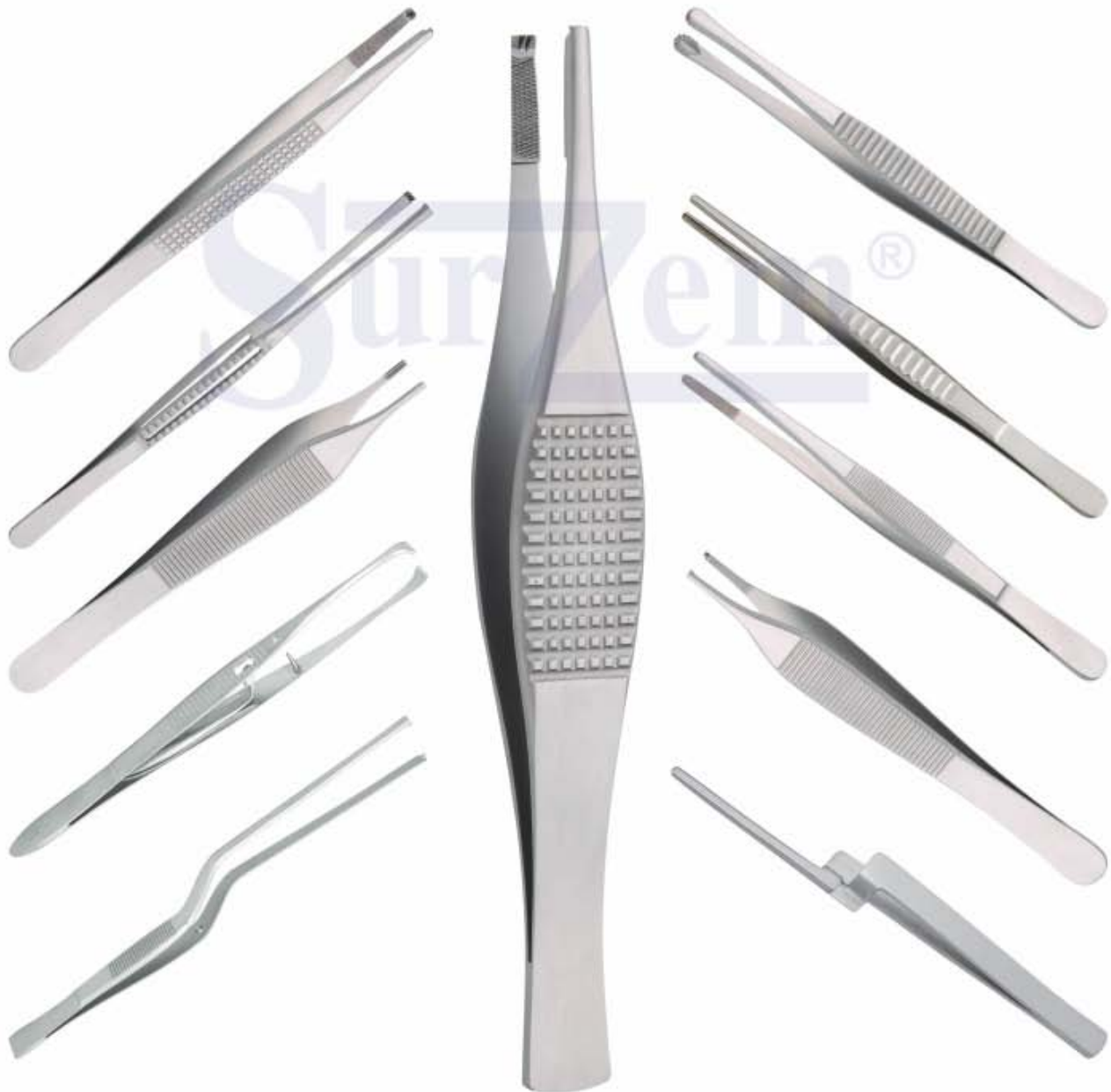

Pinzas para tejidos, Pincas à dissection | Pincas a tissu, Anatomische pinzetten
 Pinze per tessuti, Pinze per dissezione | Gewebe, Pinzas de disección



Standard Dressing Forceps
 serrated
 05-01 10.5cm
 05-02 11.5cm
 05-03 13cm
 05-04 14.5cm
 05-05 16cm
 05-06 18cm
 05-07 20cm
 05-08 25cm
 05-09 30cm

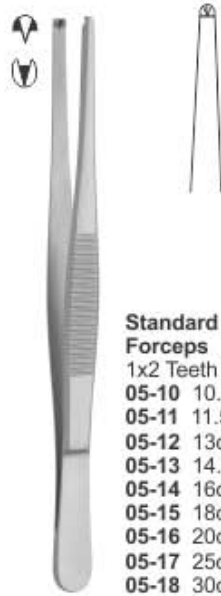

Standard Tissue Forceps
 1x2 Teeth
 05-10 10.5cm
 05-11 11.5cm
 05-12 13cm
 05-13 14.5cm
 05-14 16cm
 05-15 18cm
 05-16 20cm
 05-17 25cm
 05-18 30cm



Mod. USA, Dressing Forceps
 serrated
 05-19 10.2cm
 05-20 12cm
 05-21 13cm
 05-22 14.5cm
 05-23 15.5cm
 05-24 18cm
 05-25 21cm
 05-26 25cm
 05-27 31cm



Mod. USA, Tissue Forceps
 1x2 teeth
 05-28 10.2cm
 05-29 11.4cm
 05-30 12.7cm
 05-31 14.0cm
 05-32 15.2cm
 05-33 17.8cm
 05-34 20.3cm
 05-35 25.4cm
 05-36 30.5cm



Mod. Martin Dressing Forceps
 05-37 12.7cm
 05-38 14.0cm



Standard Dressing Forceps
 Curved, serrated
 05-39 11.4cm
 05-40 12.7cm
 05-41 14.0cm
 05-42 15.2cm
 05-43 17.8cm
 05-44 20.3cm
 05-45 25.4cm
 05-46 30.5cm



Standard Dressing Forceps
 wide pattern cross serration
 05-47 11.4cm
 05-48 12.7cm
 05-49 14.0cm
 05-50 15.20cm
 05-51 17.8cm
 05-52 20.3cm
 05-53 25.4cm
 05-54 30.5cm



Standard Dressing Forceps
 Narrow Point serrated
 05-55 12.7cm
 05-56 14 cm
 05-57 15.20cm
 05-58 17.8cm
 05-59 20.3cm
 05-60 25.4cm
 05-61 30.5cm



Semken Dressing Forceps
 Straight Serrated
 05-62 12.5cm
 05-63 15.5cm



Semken Dressing Forceps
 Curved Serrated
 05-64 12.5cm
 05-65 15.5cm



Potts-Smith Dressing Forceps
 Straight Serrated
 05-66 17.5cm
 05-67 21cm
 05-68 25 cm



Potts-Smith Dressing Forceps
 Curved Serrated
 05-69 17.5cm
 05-70 21cm
 05-71 25cm

Pinces a tissu, Anatomische pinzetten | *Pinzas para tejidos, Pinces à dissection*
Gewebe, Pinzas de disección | *Pinze per tessuti, Pinze per dissezione*



Potts-Smith Tissue Forceps
 1x2 teeth Straight
 05-72 17.5cm
 05-73 21.0cm
 05-74 25.0cm



Potts-Smith Tissue Forceps
 1x2 teeth Curved
 05-75 17.5cm
 05-76 21.0cm
 05-77 25.0cm



Brophy Dressing Forceps
 Straight Serrated
 05-78 20cm



Brophy Dressing Forceps
 Curved Serrated
 05-79 20cm



Brophy Tissue Forceps
 1x2 teeth
 Straight Serrated
 05-80 20cm



Brophy Tissue Forceps
 1x2 teeth
 Curved Serrated
 05-81 20cm



Wangensteen Dressing Forceps
 05-82 23cm



Stone Tissue Forceps
 4X5 Teeth
 05-83 15.2cm

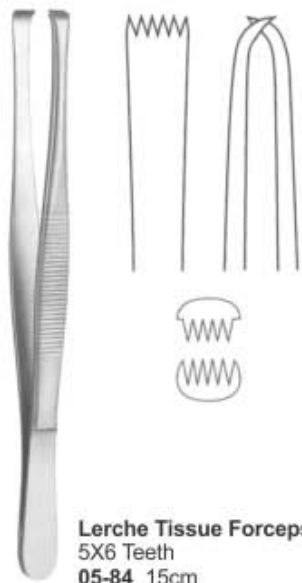

Lerche Tissue Forceps
 5X6 Teeth
 05-84 15cm

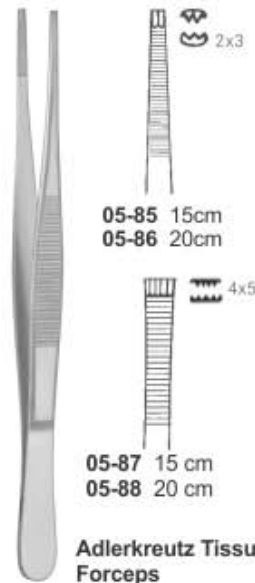

05-85 15cm
 05-86 20cm
 05-87 15 cm
 05-88 20 cm
Adlerkreutz Tissue Forceps

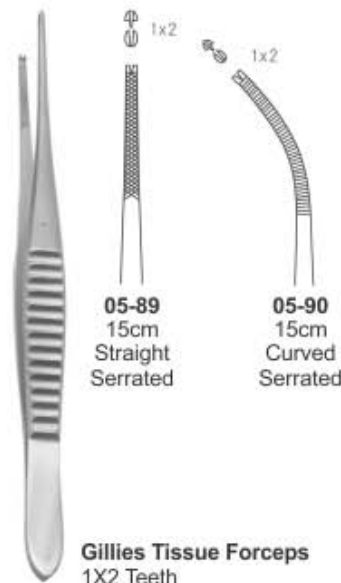

05-89 15cm
 Straight Serrated
 05-90 15cm
 Curved Serrated
Gillies Tissue Forceps
 1X2 Teeth



Treves Tissue Forceps
 1x2 Teeth
 05-91 12.5cm
 05-92 15cm
 05-93 18cm
 Dissecting Forceps
 teeth, on smooth jaws.

Pinzas para tejidos, Pincas à dissection
Pinze per tessuti, Pinze per dissezione

Pincas a tissu, Anatomische pinzetten
Gewebe, Pinzas de disección



Tissue Forceps
2x3 Teeth
05-94 11.4cm
05-95 13.0cm
05-96 14.5cm
05-97 16.0cm
05-98 17.5cm
05-99 20.0cm
05-100 25.0cm
05-101 30.0cm



Tissue Forceps
3x4 Teeth
05-102 11.4cm
05-103 13.0cm
05-104 14.5cm
05-105 16.0cm
05-106 17.5cm
05-107 20.0cm
05-108 25.0cm
05-109 30.0cm



Tissue Forceps
4x5 Teeth
05-110 11.4cm
05-111 13.0cm
05-112 14.5cm
05-113 16.0cm
05-114 17.5cm
05-115 20.0cm
05-116 25.0cm
05-117 30.0cm



Iris Tissue Forceps
1x2 Teeth, Straight
05-118 10.2 cm



Iris Tissue Forceps
1x2 Teeth, Half Curved
05-119 10.2 cm



Iris Tissue Forceps
1x2 Teeth, Full Curved
05-120 10.2 cm



Iris Forceps
05-121
10cm



Iris Tissue Forceps
1x2 teeth
05-122 10cm



Waugh Dressing Forceps
05-123 15 cm
05-124 18 cm
slightly heavier
non-toothed,
serrated jaws.



Waugh Tissue Forceps
1x2 Teeth
05-125 15 cm
05-126 18 cm
as above but one two
tooth on serrated jaws.
Known as Scott.



Leedham Tissue Forceps
1x2 Teeth
05-127 14.5 cm
05-128 18 cm
Green Dissecting
Forceps two three
teeth, smooth jaws.



Charnley Tissue Forceps
1x2 Teeth
05-129 14.5cm
05-130 18.0cm
Dissecting Forceps
one into two teeth,
block on jaws.

Pinzas para tejidos, Pincas à dissection | Pincas a tissu, Anatomische pinzetten
 Pinze per tessuti, Pinze per dissezione | Gewebe, Pinzas de disección



Ramsay Dissecting Forceps
 05-131 18cm
 serrated jaws.



Ramsay Tissue Forceps
 Dissecting Forceps
 one into teeth on
 serrated jaws.



05-132 18cm
 1x2 teeth
05-133 18cm
 2x3 teeth



Dissecting Dressing Forceps
 05-134 12.5cm
 05-135 15.0cm
 05-136 18.0cm
 turn over end,
 serrated jaws.



Dissecting Dressing Forceps
 05-137 12.5cm
 05-138 15.0cm
 05-139 18.0cm
 05-140 20.0cm
 block end, serrated
 jaws.



Ferris-Smith Tissue Forceps
 1x2 Teeth
 05-141 18cm



Ferris-Smith Tissue Forceps
 2x3 Teeth
 05-142 18cm



Lane Tissue Forceps
 1x2 Teeth
 05-143 12.5cm
 05-144 15cm
 05-145 17cm
 05-146 18cm
 05-147 20cm



Lane Tissue Forceps
 2x3 Teeth
 05-148 12.5cm
 05-149 15cm
 05-150 17cm
 05-151 18cm
 05-152 20cm



Bonney Tissue Forceps
 1x2 Teeth
 05-153 18cm



Bonney Tissue Forceps
 2x3 Teeth
 05-154 18cm

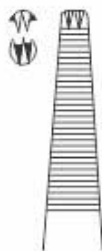

Durante Tissue Grasping Forceps
 05-155 14.5cm
 05-156 16cm
 05-157 20cm



Nelson Tissue Forceps
 05-158 23cm
 6x7 Teeth



Pinzas para tejidos, Pincas à dissection | Pincas a tissu, Anatomische pinzetten
 Pinze per tessuti, Pinze per dissezione | Gewebe, Pinzas de disección

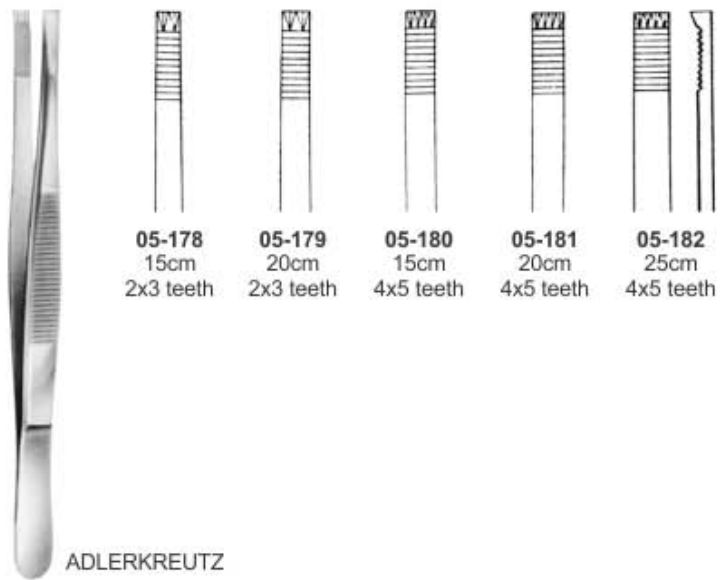
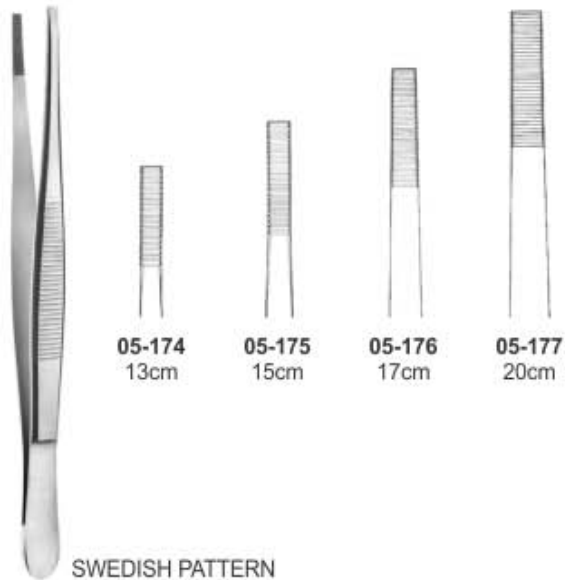
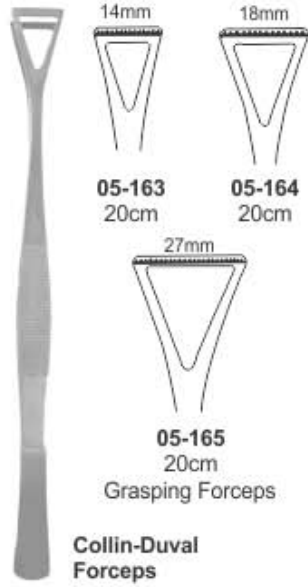

Pinzas para tejidos, Pincas à dissection | *Pincas a tissu, Anatomische pinzetten*
Pinze per tessuti, Pinze per dissezione | *Gewebe, Pinzas de disección*

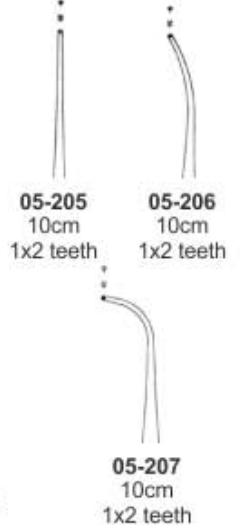
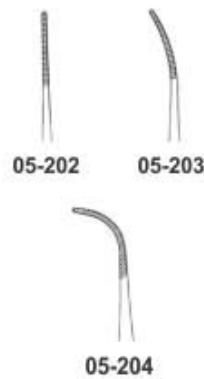
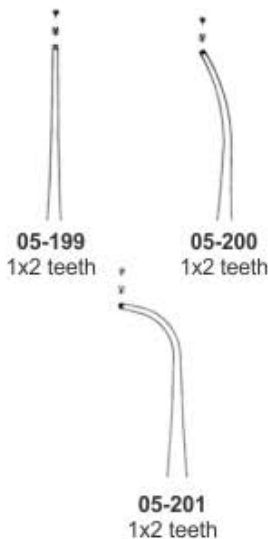
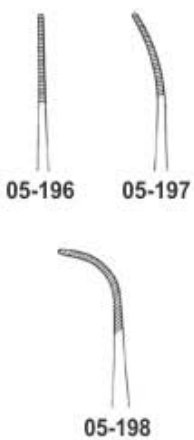
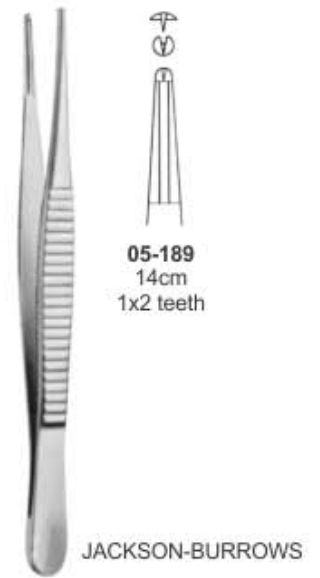
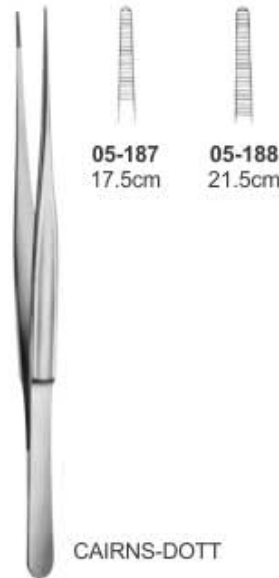
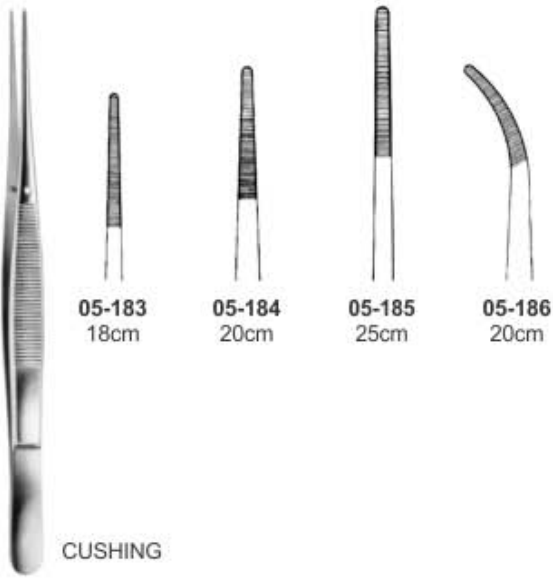

Pinzas para tejidos, Pincas à dissection
Pinze per tessuti, Pinze per dissezione

Pincas a tissu, Anatomische pinzetten
Gewebe, Pinzas de disección



05-208
14cm
05-209
16cm
05-210
20cm
Dressing,
Serrated

**LUCAE / ENT
Dressing Forceps**



**Paper Dressing
Forceps
05-211 15cm**



**Paper Dressing
Forceps
05-212 15cm**



**Paper Dressing
Forceps
05-213 15cm
Curved**



**Hunt Tumor-and
Vessel Forceps
05-214 20cm**



**Samii Forceps
Spoon-Shaped Jaws Left
24cm**



**Samii Forceps
Spoon-Shaped Jaws Right
24cm**



**Micro Tying Forceps
05-221 15.5cm**



Lucae

05-222
14cm
05-223
16cm
05-224
18cm
05-225
20cm
Dressing
Serrated



Lucae

1x2 teeth
05-226
14cm
05-227
16cm
05-228
18cm
05-229
20cm



**Adson Bayonet
Dressing Forceps
05-230 21 cm
serrated**

Pinzas para tejidos, Pincas à dissection
Pinze per tessuti, Pinze per dissezione

Pincas a tissu, Anatomische pinzetten
Gewebe, Pinzas de disección



Yasargil
05-231
20cm



Hunt
05-232
20cm



Hunt
05-233
20cm



Plain Forceps
05-234 18.5cm



Jansen
05-235 16 cm
05-236 18 cm
05-237 20 cm



Plain Forceps
05-238 16cm



Tissue Forceps
05-239 16cm



Gruenwald Forceps
05-240 14cm
05-241 20cm



Gruenwald Tissue Forceps
05-242 20cm

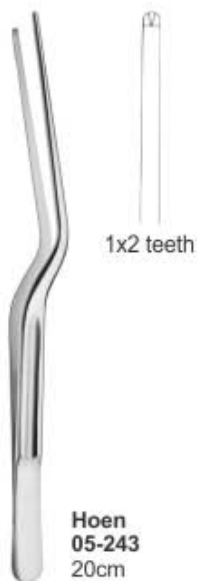

Hoen
05-243
20cm



D'Errico
05-244
22cm



D'Errico
05-245
22cm

Pinzas para tejidos, Pincas à dissection
Pinze per tessuti, Pinze per dissezione

Pincas a tissu, Anatomische pinzetten
Gewebe, Pinzas de disección



Adson
05-246
23cm



Troeltsch
05-247 10cm
05-248 12cm
05-249 15cm
05-250 17cm



Troeltsch
05-251
13cm



Wilde
05-252
11cm



Troeltsch
05-253
11.5cm



Landolt
05-254
21.5cm



0,6 mm
05-255
18cm
05-256
20 cm
05-257
22 cm
05-258
24 cm

0,9 mm
05-259
18 cm
05-260
20 cm
05-261
22 cm
05-262
24 cm

05-263
18 cm
05-264
20 cm
05-265
22 cm
05-266
24 cm
1x2 teeth

Yasargil



YASARGIL
22 cm

Ø 3,0 mm
05-267

Ø 5,0 mm
05-268



YASARGIL
22 cm

Ø 3,0 mm
05-269

Ø 5,0 mm
05-270



YASARGIL
24 cm

Ø 3,0 mm
05-271

Ø 5,0 mm
05-272

Ø 7,0 mm
05-273

Pinces a tissu, Anatomische pinzetten
Gewebe, Pinzas de disección

Pinzas para tejidos, Pinces à dissection
Pinze per tessuti, Pinze per dissezione

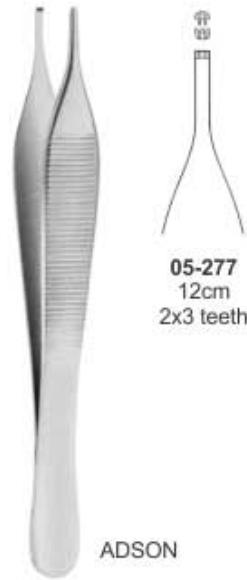
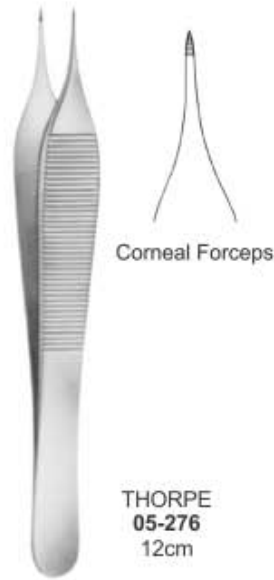
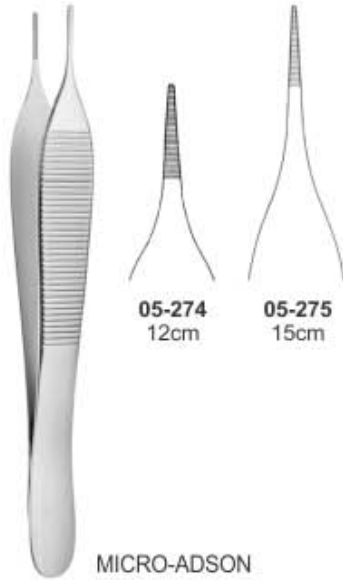

*Pincas a tissu, Anatomische pinzetten
Gewebe, Pinzas de disección*

*Pinzas para tejidos, Pincas à dissection
Pinze per tessuti, Pinze per dissezione*

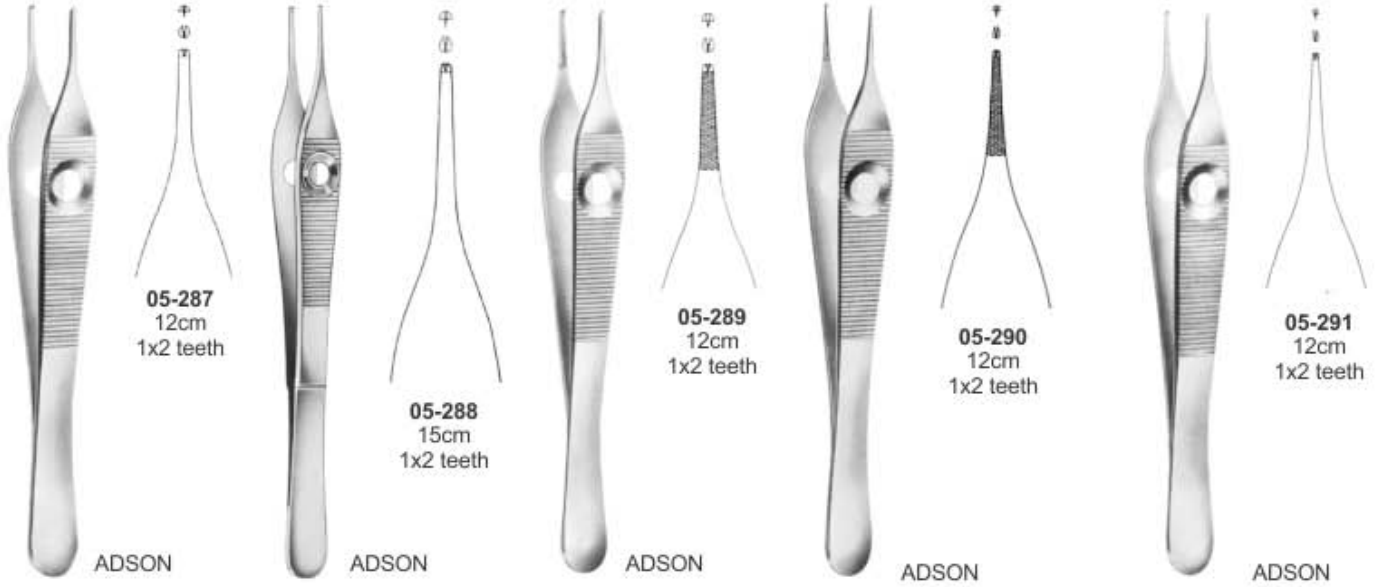

05-287
12cm
1x2 teeth

05-289
12cm
1x2 teeth

05-288
15cm
1x2 teeth

05-290
12cm
1x2 teeth

05-291
12cm
1x2 teeth

ADSON

ADSON

ADSON

ADSON

ADSON



05-292 regular point straight
05-293 fine point straight
05-294 micro point straight
12 cm, 1x2 Teeth

05-295 regular point with platform straight
05-296 fine point with platform straight
05-297 micro point with platform straight
12 cm, 1x2 Teeth

05-298 regular point curved
05-299 fine point curved
05-300 micro point curved
12 cm, 1x2 Teeth

05-301 regular point straight
05-302 fine point straight
05-303 micro point straight
12 cm, 1x2 Teeth

05-304 regular point, straight
05-305 fine point, straight
Forceps, 12cm 9x9 teeth

05-306 regular point, Curved
05-307 fine point, Curved
Forceps, 12cm 9x9 teeth

Adson Tissue Forceps
Cuter Print

Adson Brown Tissue



05-308 regular point straight
05-309 fine point straight
05-310 micro point straight
12 cm, 1x2 Teeth

05-311 regular point with platform
05-312 fine point with platform
05-313 micro point with platform
straight 12 cm, 1x2 Teeth

05-314 regular point
05-315 fine point
05-316 micro point
curved 12 cm,
1x2 Teeth

05-317 regular point
05-318 fine point
05-319 micro point
curved
12 cm, 1x2 Teeth

05-320 regular point, straight
05-321 fine point, straight
12cm 7x7 teeth

05-322 regular point, Curved
05-323 fine point, Curved
12cm 7x7 teeth

Adson Tissue Forceps
with fenestrated handle

Adson Brown
Tissue Forceps
Fenestrated Handle

Pinces a tissu, Anatomische pinzetten | *Pinzas para tejidos, Pinces à dissection*
Gewebe, Pinzas de disección | *Pinze per tessuti, Pinze per dissezione*



Graefe Forceps

05-324
7cm
05-325
10cm
straight
serrated



05-326
7cm
05-327
10cm
half curved
serrated



05-328
7cm
05-329
10cm
full curved
serrated



05-330
7cm
05-331
10cm
1x2 teeth
straight



05-332
7cm
05-333
10cm
1x2 teeth
half curved



05-334
7cm
05-335
10cm
1x2 teeth
full curved



Stevens Tissue Forceps
1x2 Teeth

05-336
11cm
straight



Stevens Tissue Forceps
1x2 Teeth

05-337
11cm
Curved



Graefe Dressing Forceps
05-338 0.5 mm
05-339 0.7 mm
05-340 1.0 mm
7cm
Straight Serrated



Graefe Dressing Forceps
05-341 0.5 mm
05-342 0.7 mm
05-343 1.0 mm
7cm
curved serrated



Graefe Tissue Forceps
1x2 Teeth
05-344 0.5 mm
05-345 0.7 mm
05-346 1.0 mm
7cm Straight



Graefe Tissue Forceps
1x2 Teeth
05-347 0.5 mm
05-348 0.7 mm
05-349 1.0 mm
7cm Curved



Graefe Fixation Forceps
05-350 11.2 cm
standard jaws 4.5mm wide
with fine teeth



05-351
90mm
05-352
105mm
05-353
115mm
05-354
125mm

Chirurgische pinzetten, Uhrmacher-Pinzetten

Pinces à dissection à groffes, Pinces d'horloger

Pinzas de disección con dientes, Pinzas de relojero

Pinze per dissezione con denti, Pinze de orologiaio



Dumont Forceps
05-355 11.5cm
curved



05-356
10.5cm
full curved



05-357
10.5cm
half curved



05-358
11cm



05-359
11cm
fine point



05-360
11cm
extra fine
point



05-361
12cm
fine point



05-362
12cm
extra fine
point



05-363
12cm



Dumont Forceps
05-364
style 1, fine point,
12cm



Dumont Forceps
05-365
style 2, strong
fine point,
12cm



Dumont Forceps
05-366
style 3, narrow
fine point,
12cm



Dumont Forceps
05-367
style 3C, narrow
fine point,
11cm



Dumont Forceps
05-368
style 4, fine point,
11cm



Dumont Forceps
05-369
style 5, super fine
11cm point



Dumont Forceps
05-370
style 5, micro fine
11cm point



Dumont Forceps
05-371
style 7, micro fine
11.5 cm curved



Dumont Forceps
05-372
style 7, fine curved,
11.5 cm



Dumont Forceps
05-373
style 6, pick up,
11.5 cm

CILIA FORCEPS

Cilienpinzetten

Pinces à épiler les cils

Pinzas depilatorias

Pinze depilatoria



Ziegler Cilia Forceps
05-374 9cm



Beer Cilia Forceps
05-375 9cm



Douglas Cilia Forceps
05-376 9cm



Gradle Cilia Forceps
05-377 10.5cm



Kuehne Cilia Forceps
05-378 10.5cm



Kuehne Cilia Forceps
05-379 10.5cm
angled sideways



Barraquer Cilia Forceps
05-380 10.5cm



Littauer Cilia Forceps
05-381 8.5cm



Littauer Cilia Forceps
05-382 9cm



Splinter Forceps
05-383 8 cm
05-384 9 cm
05-385 10.5cm
05-386 11.5cm
05-387 12.5cm
05-388 14.5cm
Straight Plain



Splinter Forceps
05-389 8cm
05-390 9cm
05-391 10.5cm
05-392 11.5cm
05-393 12.5cm
05-394 14.5cm
Curved Plain



Splinter Forceps
05-395 8cm
05-396 9cm
05-397 10.5cm
05-398 11.5cm
05-399 12.5cm
05-400 14.5cm
Straight serrated



Splinter Forceps
05-401 8cm
05-402 9cm
05-403 10.5cm
05-404 11.5cm
05-405 12.5cm
05-406 14.5cm
Curved serrated



05-407 7.5cm
05-408 9cm
05-409 11cm
Straight
Feilchenfeld Forceps

SPLINTER FORCEPS

Splitterpinzetten | Pincas à échardes
 Pinzas Para espinas | Pinze per scheggie



05-410
10.5cm
Straight

Hunter Forceps



05-411
10.5cm
Curved

Hunter Forceps



05-412
10.5cm
Straight

Carmalt Forceps



05-413
10.5cm
Curved

Carmalt Forceps



Splinter Forceps
 05-414 8cm
 05-415 9cm
 05-416 10.5cm
 05-417 11.5cm
 05-418 12.5cm
 05-419 14.5cm
 Straight serrated
 with guide pin



Splinter Forceps
 05-420 8cm
 05-421 9cm
 05-422 10.5cm
 05-423 11.5cm
 05-424 12.5cm
 05-425 14.5cm
 Curved serrated with
 guide pin



Splinter Forceps
 05-426 8cm
 05-427 9cm
 05-428 10.5cm
 05-429 11.5cm
 05-430 12.5cm
 05-431 14.5cm
 Straight plain with
 guide pin



Splinter Forceps
 05-432 8cm
 05-433 9cm
 05-434 10.5cm
 05-435 11.5cm
 05-436 12.5cm
 05-437 14.5cm
 Curved plain with
 guide pin



**Stieglitz Forceps
 with Magnifying
 Mirrors**
 05-438 12.5cm



Ochsner Forceps
 05-439 14cm



**Lange Tissue
 Forceps**
 05-440 10cm



**Childe Tissue
 Forceps**
 05-441 18cm



**Michel Tissue
 Forceps**
 05-442 12cm



**Wachenfeldt
 Tissue Forceps**
 05-443 12.5cm



**Hegenbarth
 Tissue Forceps**
 05-444 12.5cm

Splitterpinzetten | Pincas à échardes
 Pinzas Para espinas | Pinze per scheggie



**Wachenfeldt
Tissue Forceps**
05-445 12.5cm



Stieglitz Splinter Forceps
05-446 14cm Str.
05-447 14cm 45° Angled

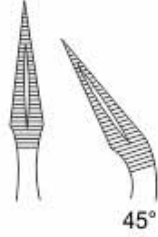

45°



Stieglitz Splinter Forceps
05-448 14cm, 90° Angled

90°



Peet Splinter Forceps
05-449 11.5cm

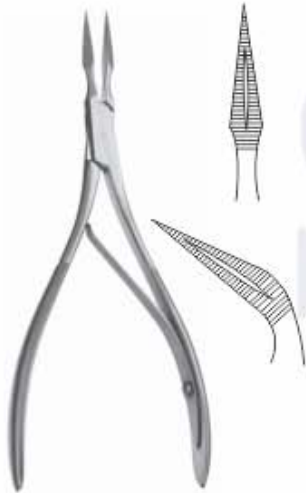

Ralk Splinter Forceps
05-450 15cm, Str.
05-451 15cm, Cvd.



Michel Forceps
05-452 12cm



Michel Clips
05-453
sizes: 11mm x 3mm
& 18mm x 3mm.



Mod. Michel Forceps
05-454 12cm



Collin Forceps
05-455 13cm



Richter-Heath Forceps
05-456 14cm



1.5 mm

05-457
14cm

3.0 mm

05-460
20cm

T.C Oehler Tissue Forceps

2.0 mm

05-458
16cm

3.7 mm

05-461
25cm

2.7 mm

05-459
18cm

4.0 mm

05-462
30cm



0.4 mm

05-463
15cm

**Semken
with dissector
end**



0.2 mm

05-464
16cm

0.2 mm

05-465
18cm

**Semken
1x2 teeth**



1.5 mm

05-466
15cm

2.0 mm

05-467
19cm

05-468
24cm

**T.C De Bakey
Dressing Forceps**



0.4 mm

**T.C Gillies
Tissue Forceps**
05-469 15cm

*Pincas a tissu, Anatomische pinzetten
Gewebe, Pinzas de disección*

*Pinzas para tejidos, Pincas à dissection
Pinze per tessuti, Pinze per dissezione*

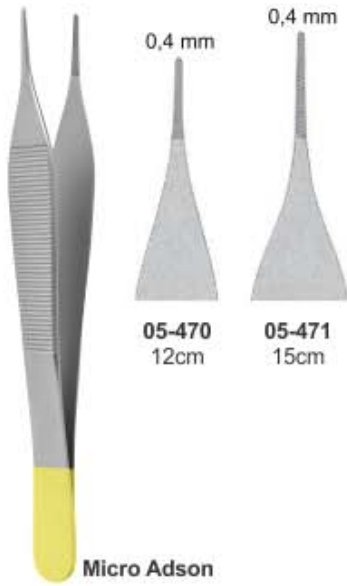

Micro Adson



Adson



Adson



**Micro Adson
Light Weight**



**Adson
Light Weight**



**Adson
Light Weight**



**Micro Adson Tissue
Forceps 1x2 teeth**



**Adson Tissue Forceps
1x2 teeth**



**Adson Tissue Forceps
3x4 teeth**

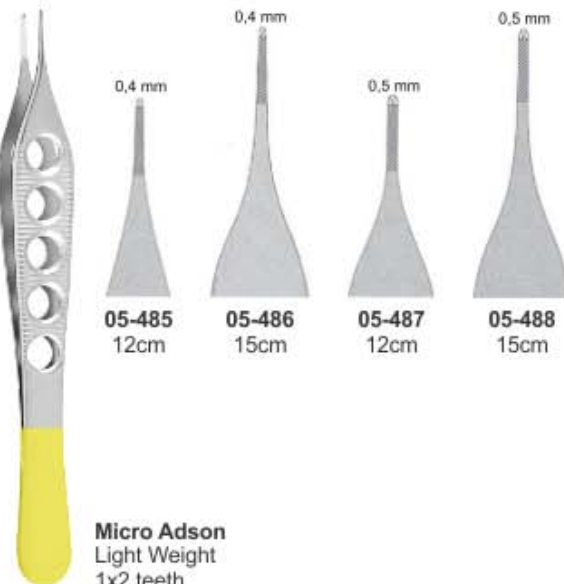

**Micro Adson
Light Weight
1x2 teeth**

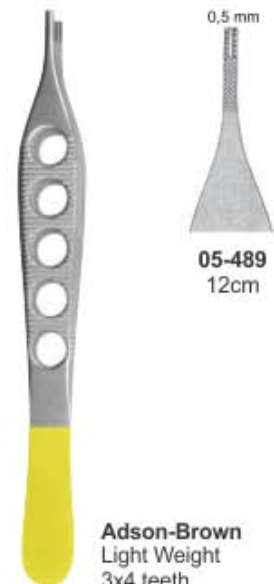

**Adson-Brown
Light Weight
3x4 teeth**

Pincas a tissu, Anatomische pinzetten | *Pinzas para tejidos, Pincas à dissection*
Gewebe, Pinzas de disección | *Pinze per tessuti, Pinze per dissezione*

